

No.	Nimike	Nimitys	Description	Dimension	pcs
1	RC19143	Nivelaura	Articulated plough	NAH275	1
2	RC10119	Reikälevy	Hole plate	20x150x280	2
3	310912	Levy	Plate	1x73x280	4
4	RC14986	Säätöjalka	Adjustable leg	TR36	2
5	20087	Kuusioruuvi	Hex screw	M20x90 DIN 931	10
6	20249	Kuusioruuvi	Hex screw	M16x30 DIN 933	2
7	10035	Lukitusmutteri	Lock nut	M20 DIN 985	10
8	10006	Aluslevy	Washer	M16 DIN125 A16	2
9	17010	Rasvanippa	Grease nipple	M8x1.25	8

**FMG Oy**  
 Levytie 4  
 74510 Iisalmi  
 Tel 020 1984 020

Articulated plough  
 Nivelaura  
 NAH275

Piir no  
**RC19220**

Rev

Korvaa

Korvattu

Pvm	Nimi	Muutos	Merkki
-----	------	--------	--------

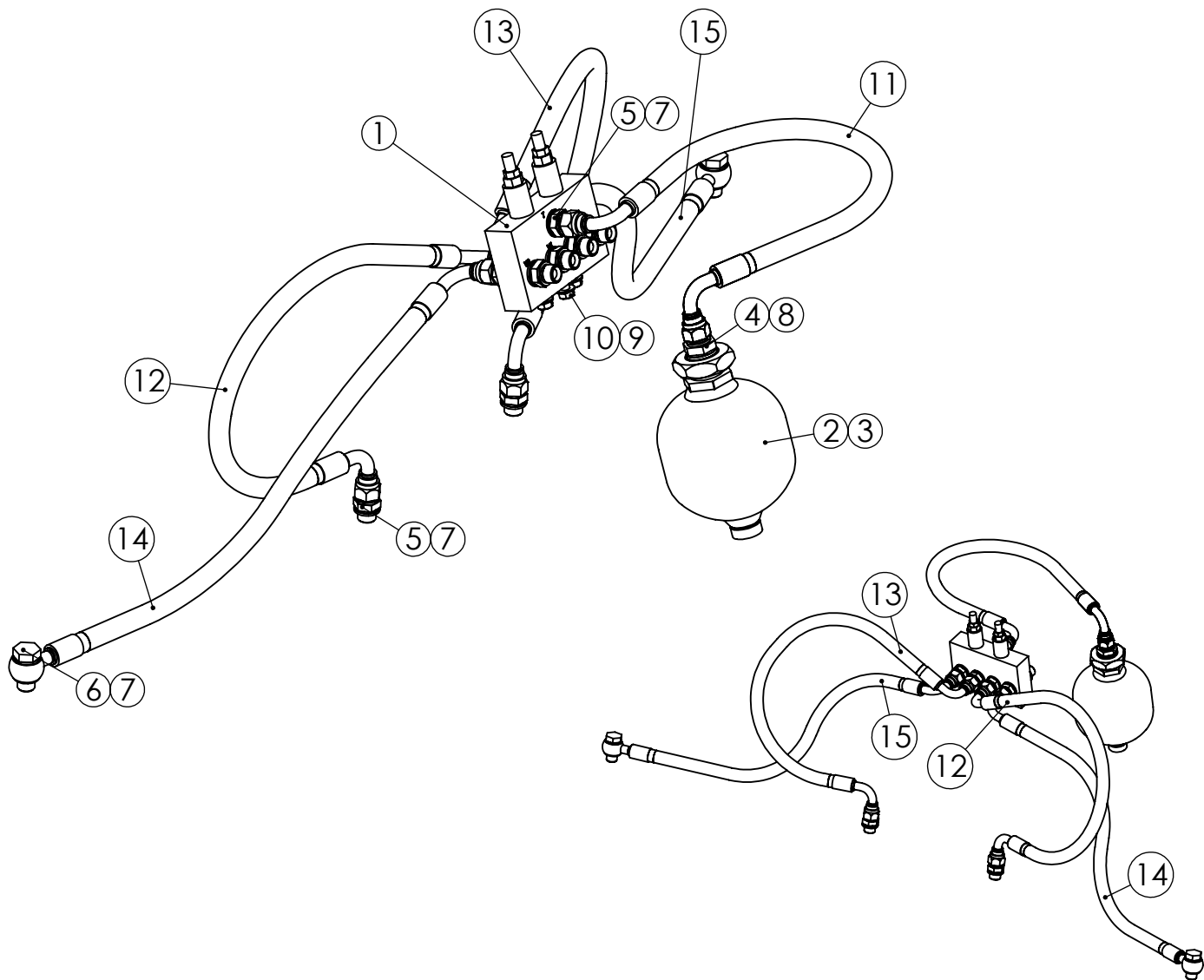

No.	Nimike	Nimitys	Description	Dimension	pcs
1	23027	Paineenrajoitusventtiili	Pressure relief valve	KVVP38	1
2	11015	Paineakku	Accumulator	SBO210-0,75E1_U-210AK050 0,75l 50 bar	1
3	10082	Kuusiomutteri, matala	Hexagon Nut	M33x1.5 DIN 936	1
4	17030	Supistusnippa	Double nipple	R3-8_R1-2	1
5	17031	Kaksoisnippa	Lead through nipple	R3-8	11
6	20182	Banjoruuvi	Banjo screw	R 3/8 lyhyt malli	2
7	21023	Tiiviste	Seal ring	USIT R3/8	15
8	21024	Tiiviste	Seal ring	USIT R1/2	1
9	10015	Aluslevy	Washer	M8 DIN125 A8	3
10	20099	Kuusioruuvi	Hex screw	M8x20 DIN 933	3
11	16106	Letkuasennelma	Hose assembly	06-R2T-600-3/8S90-3/8S90	1
12	16113	Letkuasennelma	Hose assembly	06-R2T-640-3/8S90-3/8S90	1
13	16113	Letkuasennelma	Hose assembly	06-R2T-640-3/8S90-3/8S90	1
14	16382	Letkuasennelma	Hose assembly	06-R2T-760-3/8 banjo-3/8S 90	1
15	16382	Letkuasennelma	Hose assembly	06-R2T-760-3/8 banjo-3/8S 90	1
16	RC19229	Letkusetti	Hose assembly	NAH275	1

**FMIG**  
FARM MACHINERY GROUP

Levytie 4  
74510 Iisalmi  
Tel 020 1984 020

Hydrauliikka, vakio  
NAH275

Piir. nro.

RC19228

Rev

Pvm	Nimi	Muutos	Merkki
-----	------	--------	--------

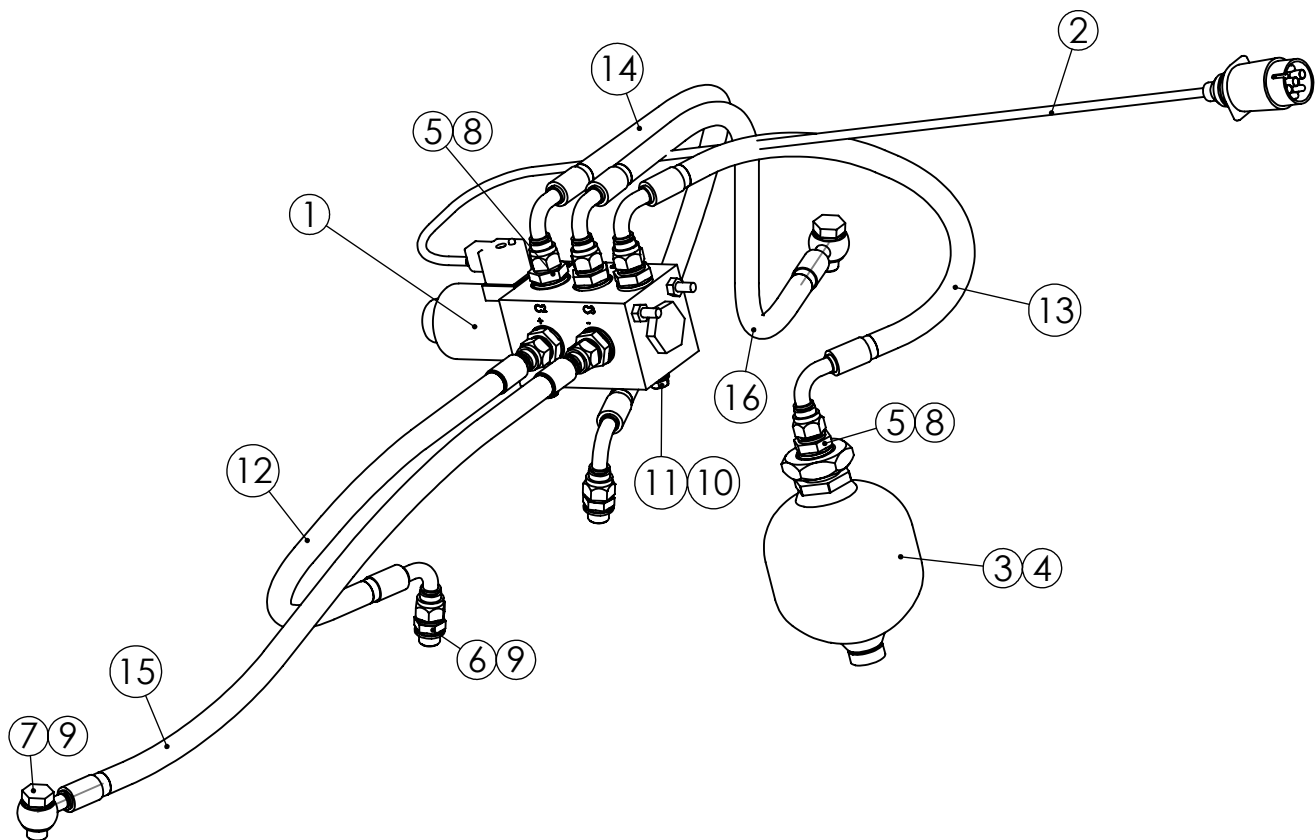

No.	Nimike	Nimitys	Description	Dimension	pcs
1	23013	Valintaventtiili	Section valve	6/2 E6212PV-12VDC	1
2	19021	Johtosarja	Wiring harness	3m, Piippo	1
3	11015	Paineakku	Accumulator	SBO210-0,75E1_U-210AK050 0,75l 50 bar	1
4	10082	Kuusiomutteri, matala	Hexagon Nut	M33x1.5 DIN 936	1
5	17030	Supistusnippa	Double nipple	R3-8_R1-2	8
6	17031	Kaksoisnippa	Lead through nipple	R3-8	2
7	20182	Banjoruuvi	Banjo screw	R 3/8 lyhyt malli	2
8	21024	Tiiviste	Seal ring	USIT R1/2	8
9	21023	Tiiviste	Seal ring	USIT R3/8	6
10	10015	Aluslevy	Washer	M8 DIN125 A8	3
11	20099	Kuusioruuvi	Hex screw	M8x20 DIN 933	3
12	16107	Letkuasennelma	Hose assembly	06-R2T-550-3/8S90-3/8S	1
13	16106	Letkuasennelma	Hose assembly	06-R2T-600-3/8S90-3/8S90	1
14	16113	Letkuasennelma	Hose assembly	06-R2T-640-3/8S90-3/8S90	1
15	16668	Letkuasennelma	Hose assembly	06-R2T-650-3/8banjo-3/8S	1
16	16382	Letkuasennelma	Hose assembly	06-R2T-760-3/8 banjo-3/8S 90	1
17	RC19227	Letkusetti	Hose assembly	NAH	1

**FMIG**  
FARM MACHINERY GROUP

Levytie 4  
74510 Iisalmi  
Tel 020 1984 020

Electric valve  
Sähköventtiili  
NAH275 6/2 12VDC

Piir. nro.

RC19226

Rev

Pvm	Nimi	Muutos	Merkki
-----	------	--------	--------

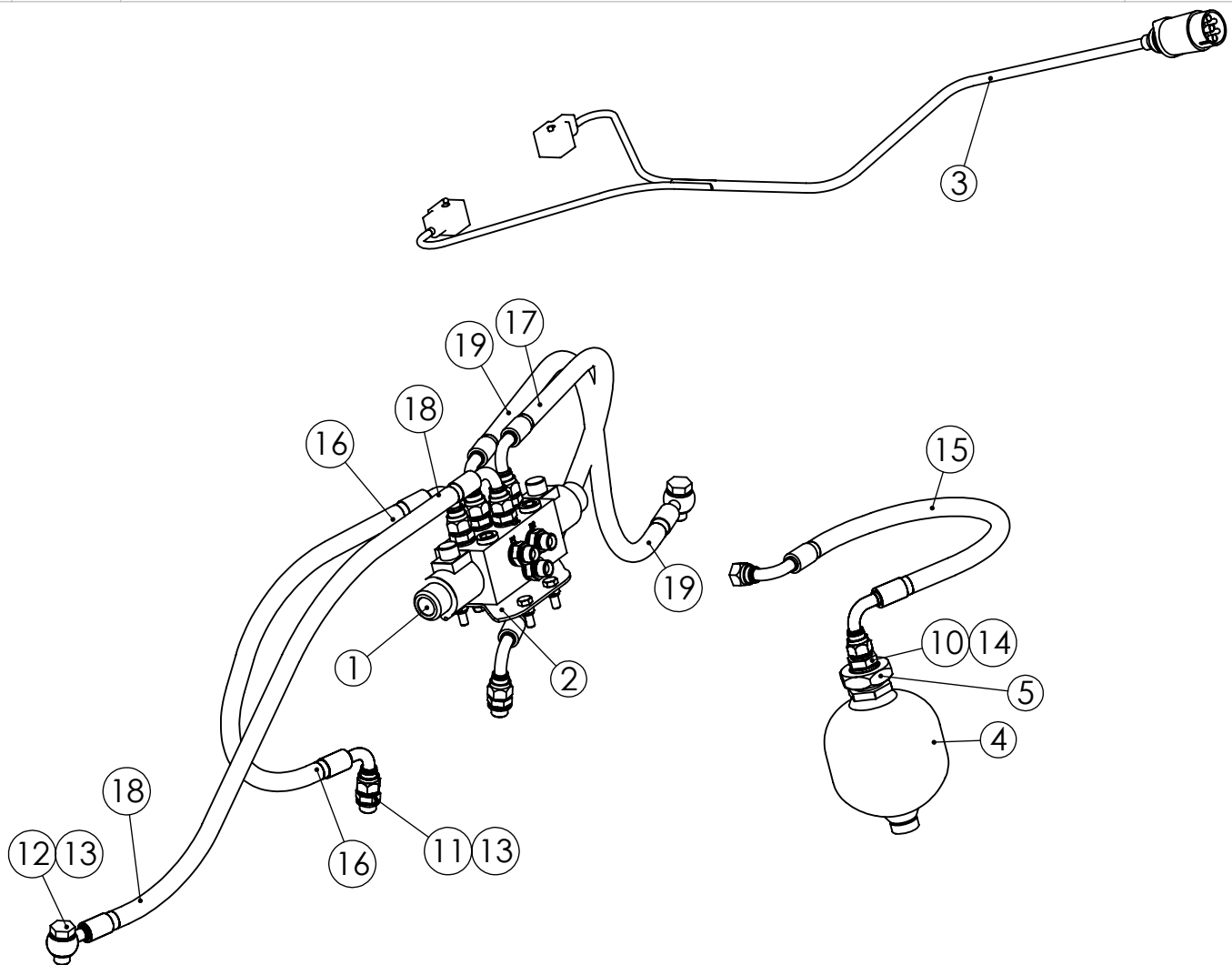

No.	Nimike	Nimitys	Description	Dimension	pcs
1	23181	Valintaventtiili	Section valve	8/3 E8338PV-12VDC	1
2	RC19237	Levy		3x122x128	1
3	19244	Johtosarja	Wiring harness	3m, Piippo 2 pistoketta	1
4	11015	Paineakku	Accumulator	SBO210-0,75E1_U-210AK050 0,75l 50 bar	1
5	10082	Kuusiomutteri, matala	Hexagon Nut	M33x1.5 DIN 936	1
6	20184	Kuusioruuvi	Hex screw	M8x16 DIN 933	4
7	20100	Kuusioruuvi	Hex screw	M8x25 DIN 933	4
8	10042	Lukitusmutteri	Lock nut	M8 DIN 985	4
9	10015	Aluslevy	Washer	M8 DIN125 A8	4
10	17030	Supistusnipa	Double nipple	R3-8_R1-2	1
11	17031	Kaksoisnipa	Lead through nipple	R3-8	9
12	20182	Banjoruuvi	Banjo screw	R 3/8 lyhyt malli	2
13	21023	Tiiviste	Seal ring	USIT R3/8	13
14	21024	Tiiviste	Seal ring	USIT R1/2	1
15	16106	Letkuasennelma	Hose assembly	06-R2T-600-3/8S90-3/8S90	1
16	16113	Letkuasennelma	Hose assembly	06-R2T-640-3/8S90-3/8S90	1
17	16113	Letkuasennelma	Hose assembly	06-R2T-640-3/8S90-3/8S90	1
18	16382	Letkuasennelma	Hose assembly	06-R2T-760-3/8 banjo-3/8S 90	1
19	16382	Letkuasennelma	Hose assembly	06-R2T-760-3/8 banjo-3/8S 90	1
20	RC19229	Letkusetti	Hose assembly	NAH275	1

**FMIG**  
FARM MACHINERY GROUP

Levytie 4  
74510 Iisalmi  
Tel 020 1984 020

Hydrauliikka, diag  
NAH275, 12V

Piir. nro.

RC19230

Rev

Pvm	Nimi	Muutos	Merkki
-----	------	--------	--------

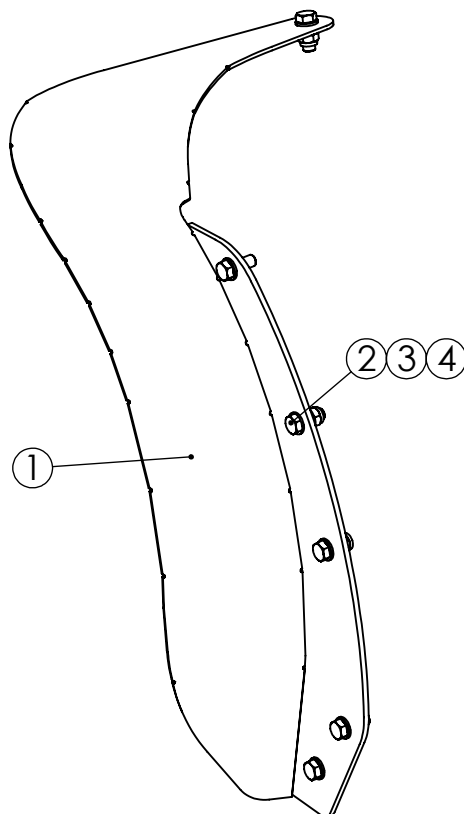

No.	Nimike	Nimitys	Description	Dimension	pcs
1	RC19146	Siipi	Wing	NAH, vasen	1
2	20071	Kuusioruuvi	Hex screw	M16x40 DIN 933	6
3	10033	Lukitusmutteri	Lock nut	M16 DIN 985	3
4	10006	Aluslevy	Washer	M16 DIN125 A16	9

**FMIG**  
FARM MACHINERY GROUP

**Levytie 4**  
**74510 Iisalmi**  
**Tel 020 1984 020**

Additional wing  
Lisäsiipi  
NAH vasen, lyhyt

Piir. nro.

**RC19222**

Rev

Pvm	Nimi	Muutos	Merkki
-----	------	--------	--------

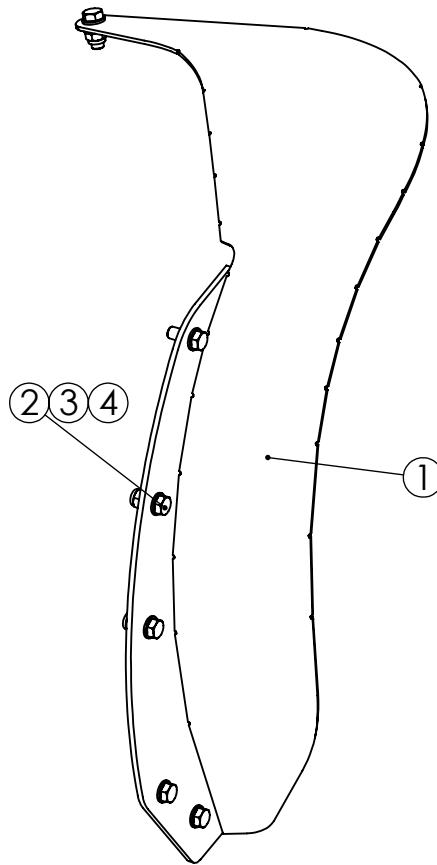

No.	Nimike	Nimitys	Description	Dimension	pcs
1	RC19173	Heittosiipi		NAH oikea	1
2	20071	Kuusioruuvi	Hex screw	M16x40 DIN 933	6
3	10033	Lukitusmutteri	Lock nut	M16 DIN 985	3
4	10006	Aluslevy	Washer	M16 DIN125 A16	9

**FMIG**  
FARM MACHINERY GROUP

**Levytie 4**  
**74510 Iisalmi**  
**Tel 020 1984 020**

Additional wing  
Lisäsiipi  
NAH, oikea, lyhyt

Piir. nro.

**RC19221**

Rev

Pvm	Nimi	Muutos	Merkki
-----	------	--------	--------

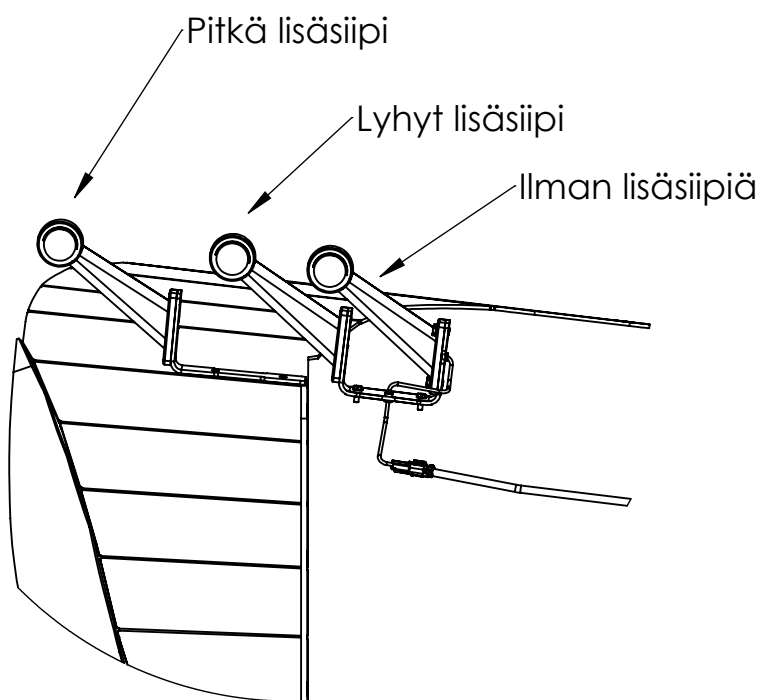
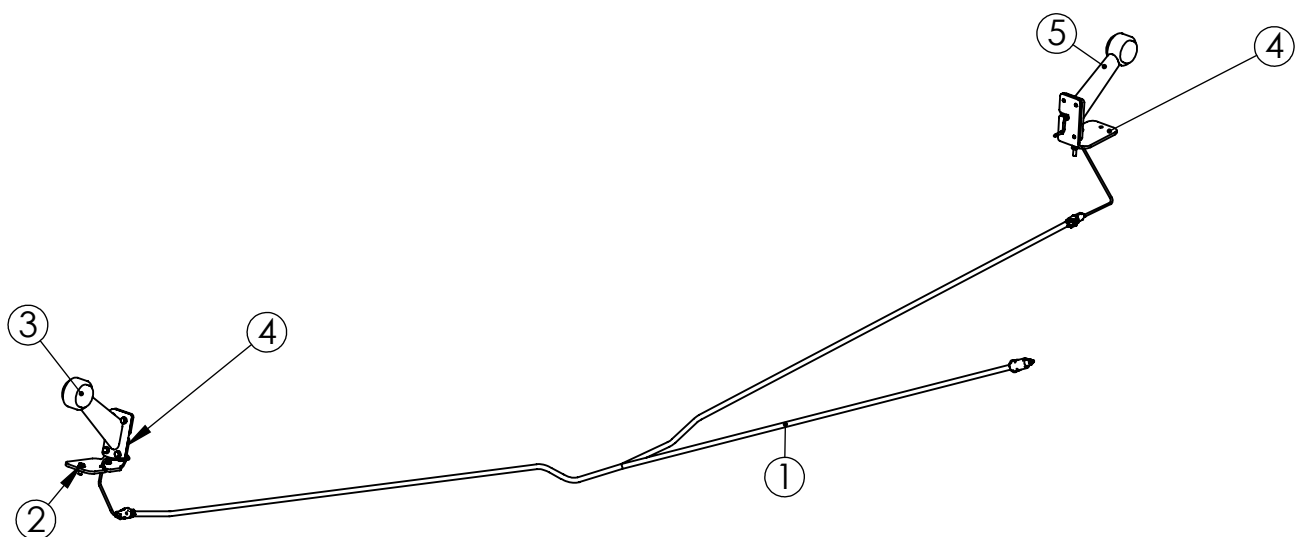

No.	Nimike	Nimitys	Description	Dimension	pcs
1	RC21768	Kaapelisarja	Cable set	Äärivalot	1
2	20290	Kuusioruuvi	Hex screw	TAPTITE DIN 7500-D ZN M6X16	12
3	RC21766	Äärivalo		vasen	1
4	RC21767	Levy		5x225x70	2
5	RC21765	Äärivalo		oikea	1

**FMIG**  
FARM MACHINERY GROUP

Levytie 4  
74510 Iisalmi  
Tel 020 1984 020

Side light  
Äärivalot  
NAH

Piir nro.

RC21764

Rev

Pvm	Nimi	Muutos	Merkki
-----	------	--------	--------

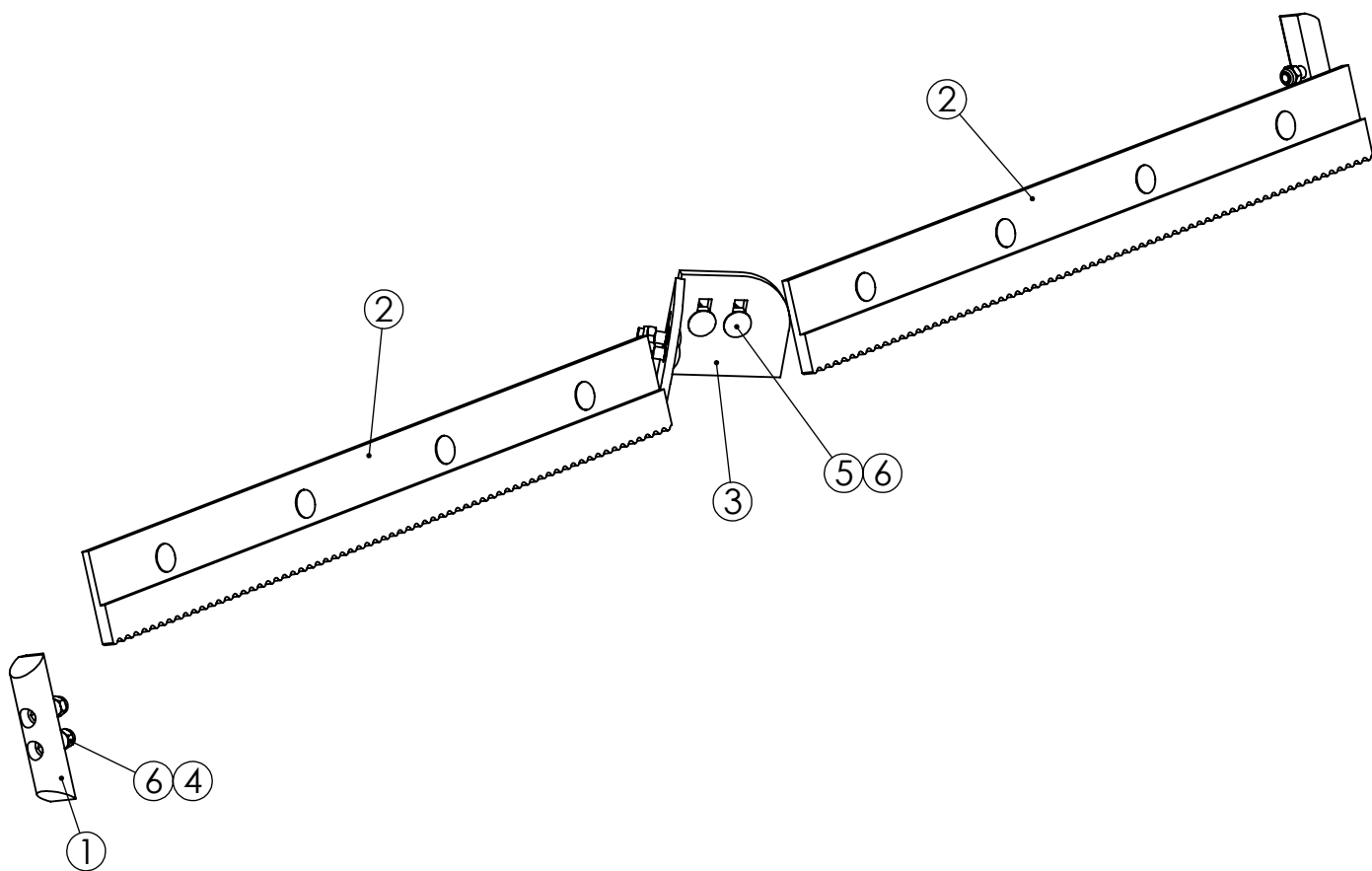

No.	Nimike	Nimitys	Description	Dimension	pcs
1	RC07303	Kulutustappi	Wear pin	D50-200	2
2	13128	Kovametallipolanneterä	Hard metal ice blade	11/19x130x1220	2
3	RC19138	Kulutuslevy	Wear plate	12x150x165	2
4	20280	Kuusiokoloruuvi	Allen screw	M16x45 DIN 912 8,8	4
5	20115	Lukkoruuvi	Lock screw	M16x50 DIN603	12
6	10033	Lukitusmutteri	Lock nut	M16 DIN 985	16

**FMIG**  
FARM MACHINERY GROUP

**Levytie 4**  
**74510 Iisalmi**  
**Tel 020 1984 020**

Polanneterät  
NAH275

Piir nro.

**RC19241**

Rev



Pvm	Nimi	Muutos	Merkki
-----	------	--------	--------

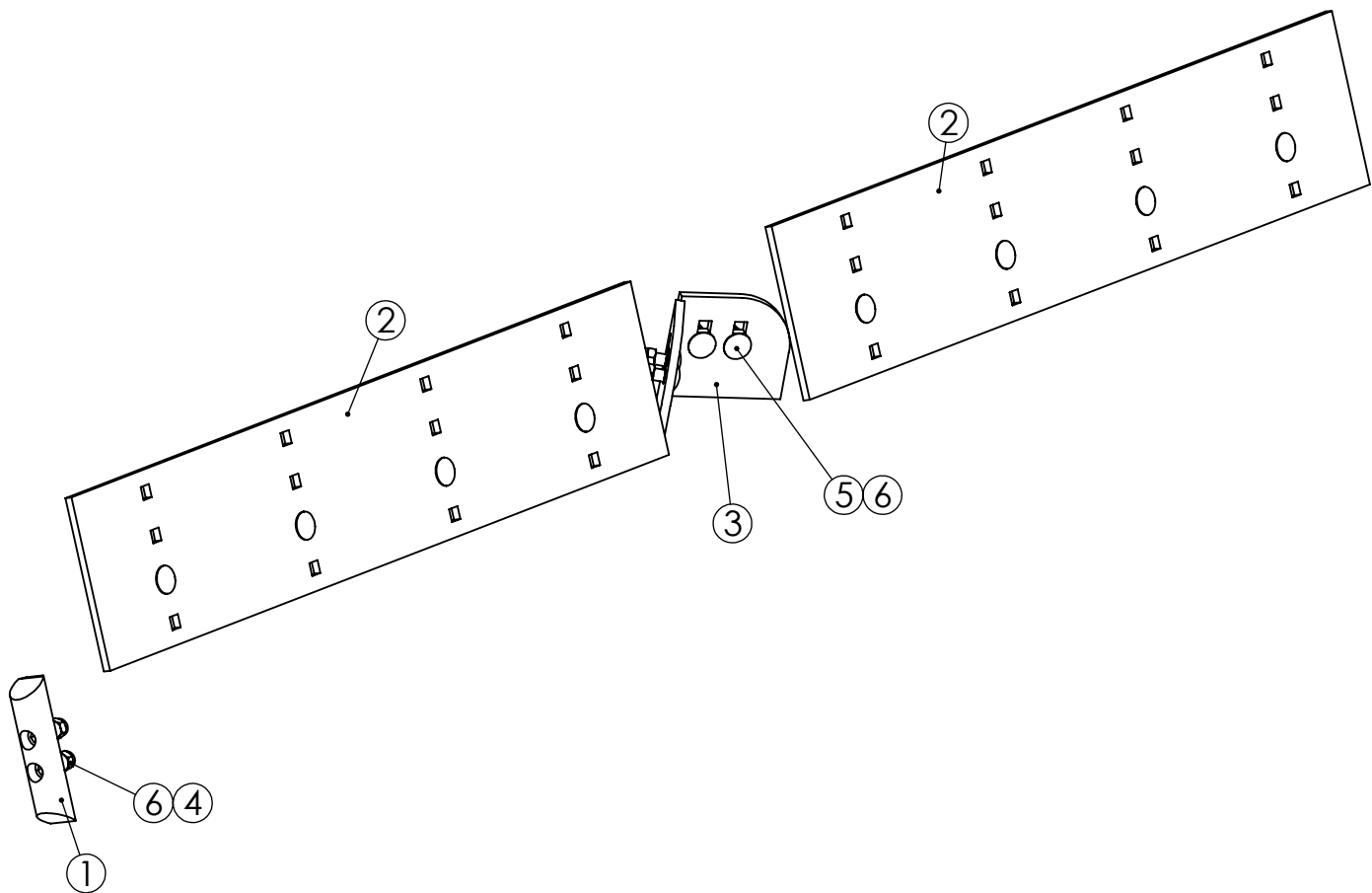

No.	Nimike	Nimitys	Description	Dimension	pcs
1	RC07303	Kulutustappi	Wear pin	D50-200	2
2	13042	Kumireikäterä	Rubber perforated blade	11x240x1220	2
3	RC19138	Kulutuslevy	Wear plate	12x150x165	2
4	20280	Kuusiokoloruuvi	Allen screw	M16x45 DIN 912 8,8	4
5	20115	Lukkoruuvi	Lock screw	M16x50 DIN603	12
6	10033	Lukitusmutteri	Lock nut	M16 DIN 985	16

**FMIG**  
FARM MACHINERY GROUP

**Levytie 4**  
**74510 Iisalmi**  
**Tel 020 1984 020**

**Kumiverkkoterät**  
**NAH275**

Piir. nro.

**RC19240**

Rev

Pvm	Nimi	Muutos	Merkki
-----	------	--------	--------

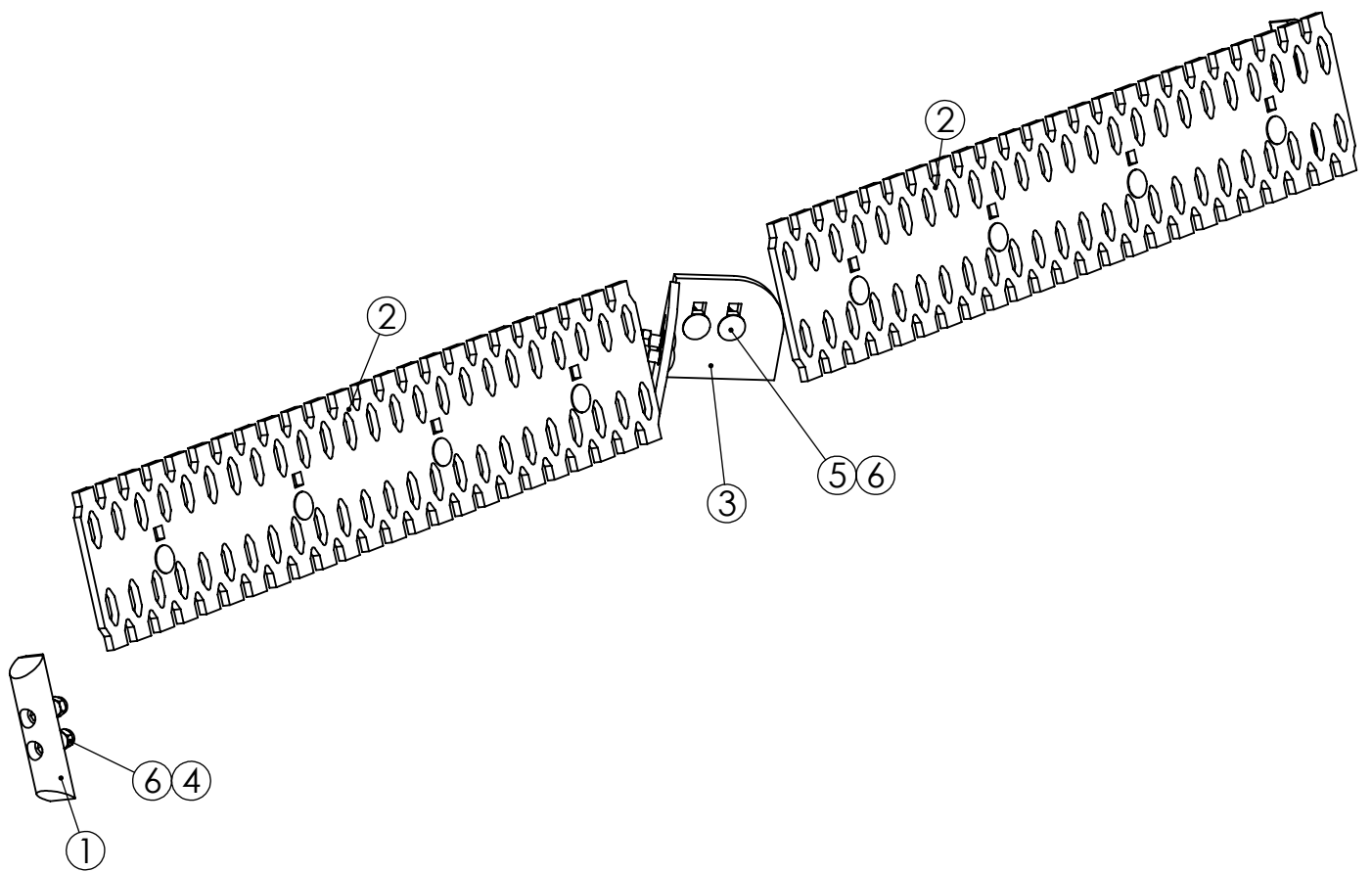

No.	Nimike	Nimitys	Description	Dimension	pcs
1	RC07303	Kulutustappi	Wear pin	D50-200	2
2	13121	Verkkoterä	Perforated blade	12x220x1220	2
3	RC19138	Kulutuslevy	Wear plate	12x150x165	2
4	20280	Kuusiokoloruuvi	Allen screw	M16x45 DIN 912 8,8	4
5	20115	Lukkoruuvi	Lock screw	M16x50 DIN603	12
6	10033	Lukitusmutteri	Lock nut	M16 DIN 985	16

**FMIG**  
FARM MACHINERY GROUP

**Levytie 4**  
**74510 Iisalmi**  
**Tel 020 1984 020**

Perforated blades  
Verkkoterät  
NAH275

Piir nro.

**RC19239**

Rev

Pvm	Nimi	Muutos	Merkki
-----	------	--------	--------

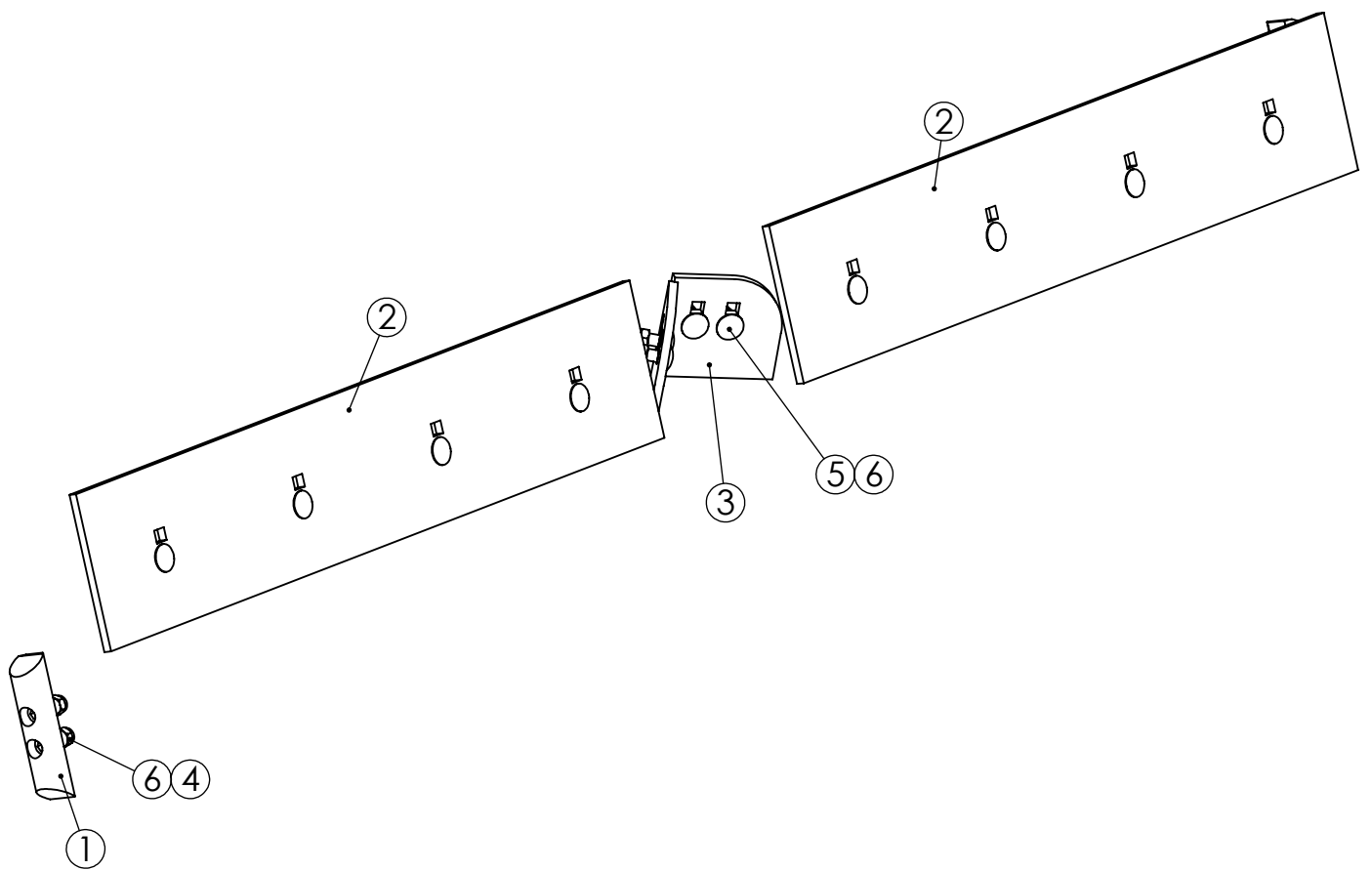

No.	Nimike	Nimitys	Description	Dimension	pcs
1	RC07303	Kulutustappi	Wear pin	D50-200	2
2	13115	Tasaterä	Flat blade	12x220x1220	2
3	RC19138	Kulutuslevy	Wear plate	12x150x165	2
4	20280	Kuusiokoloruuvi	Allen screw	M16x45 DIN 912 8,8	4
5	20115	Lukkoruuvi	Lock screw	M16x50 DIN603	12
6	10033	Lukitusmutteri	Lock nut	M16 DIN 985	16

**FMIG**  
FARM MACHINERY GROUP

Levytie 4  
74510 Iisalmi  
Tel 020 1984 020

Even blades  
Tasaterät  
NAH275

Piir nro.

RC19225

Rev